

ROLLINGSHIELD



s h u t t e r s



Rollingshield™ is your partner in the Hurricane Shutter Industry

Quality.Service.Value

Rollingshield™ has been proud to serve the U.S. Market since 1993. As a manufacturer of high quality shutters and shades, Rollingshield™ has helped to protect countless homes and businesses in Florida, the Caribbean, the Gulf States and Mid-Atlantic Coast against the ravages of Hurricanes and Tropical Storms. Our continuing mission is to develop and produce the best shutters available in order to serve our customers' needs.



ROLLINGSHIELD™
SHUTTERS • SHADES

(800) 474-9404
www.rollingshield.com

Index - **Components**

Shutter Diagram	4
PVC and Foam-Filled Slats	5
Extruded Aluminum Slats	7
RS Retention Slats	8
Extruded Aluminum End Slats	9
Extruded Aluminum Side Rails	12
Aluminum Housings	15
Aluminum Side Caps	18
Safety Plates	23
Roller Guides	24
Slat Hangers	26
Roller Tubes	28
Idler Caps	30
Shaft Couplers and Shaft Caps	32
Adapter Rings	33
Support Brackets	34
Ball Bearings and Ball Bearing Holders	36
Reduction Gears and Inserts	38
Universals and Handles	42
Slat Locks	44
General Parts	51
Extruded Aluminum Angles	53
Extruded Aluminum Square Tubes	55
Terms and Conditions	56



Terms and Conditions of Sale

Contractual Parties

Rolling Shield Parts, Inc., a Florida Corporation, herein after Supplier, and the purchaser of the goods and/or service sold by Rolling Shield Parts, Inc. hereunder Buyer mutually agree to abide by the terms and conditions of sales stated below.

Acceptance

All offers, quotes, job estimates and sales by Supplier are subject to the terms and conditions of sales stated herein. By taking delivery of products and/or services provided by Supplier, Buyer agrees to these terms and conditions unless otherwise expressly agreed under separate written contract and signed by the party's legal representatives. The terms and conditions stated herein shall prevail over any different or additional terms and conditions proposed by Buyer and shall apply to the sale or shipment of any goods in response to Buyer's order. Supplier hereby objects to any different or additional terms and conditions, which may be proposed or have been proposed by Buyer in any purchase, order forms or other documents.

Prices and Delivery

All price lists and/or quoted process are subject to change without notice. Prices on accepted orders shall remain firm for a period of 90 days from the date of order confirmation, provided that the final delivery occurs within that period. All prices are in U.S. Dollars F.O.B. Supplier's warehouse in Miami or Ft. Myer8, FL, excluding freight, packaging and taxes. Delivery dates on job estimates, quotes and/or orders confirmations are approximate.

Payment Terms

Payment terms for transactions other than credit accounts shall be stated on each quote, job estimate and/or order confirmation and will be strictly adhered to. Payment terms on credit accounts are net 30 days from date of invoice. Amounts past due on credit accounts are subject to finance charges at the highest rate allowed by law. Supplier retains the right to halt further deliveries and service to the buyer until all past due amounts have been paid, and to require payment in advance for orders not yet delivered.

Inspection and Claims

All claims against Supplier for shortages, damages, etc., must be made in writing to Suppliers within 24 hours of the date of receipt of shipment otherwise all claims are waived.

Risk of Loss

Buyer assumes all risks of loss, damage of the goods upon Supplier's delivery of the goods to the carrier at the point of shipment.

Force Majeure

If an order cannot be completed due to causes beyond Supplier's control Supplier retains the right to either cancel the incomplete portion of the order or complete the order if and when this becomes possible. Buyer shall not have the right to withhold payment on delivered goods and/or services. Force Majeure includes but is not limited to strikes, lockouts, storms, floods, and the like, wars, revolutions, major equipment failures or fire damage at the storage and/or production facilities, and other such acts of God or man.

Warranty

Supplier warrants all products against defects in material and workmanship for a period of (2) two years from the date of delivery. If any part or component does not function as intended during the warranty period, Supplier will provide a replacement part to Buyer when Supplier has received the original malfunctioning part or component as claimed by Buyer. This warranty does not apply in case of physical abuse or damage, misuse, misapplication or any defects due to faulty merchantability or of fitness for a particular purpose. This warranty does not apply to third party users.

Returns

No goods may be returned without the express written approval of Supplier and without a written authorization number. Buyer shall obtain such documented authorization and return authorization number before any materials or goods can be processed. Returned materials or goods must include the authorization number on all packaging and on all documents related to the materials or goods being returned. Goods approved for return must be in its unaltered stated and in the original container or packaging and must be in saleable condition. All returned packages must be shipped freight prepaid and accompanied by a copy of the original invoice. All credits for returned items are subject to Supplier's acceptance after inspection at its plant. Supplier retains the right to apply a restocking charge of 20% of the original invoice value on all returned goods.

Limited Liability

Supplier's liability for any and all claims, charges, expenses, damages, losses and injuries arising out of or relating to its performance or breach of any agreement of sales of goods and the manufacture, sales, deliver, resale, repair or use of any goods shall not exceed the purchase price of such goods. This shall be Buyer's sole and exclusive remedy against Suppliers outside of the remedy provided under Supplier's warranty. Buyer agrees that in no event shall Supplier be liable for incidental, special or consequential damages or for injuries to third parties.

Liens and Security Interest

Buyer shall not allow any undischarged lien, encumbrance or charges upon the goods sold by Supplier until Supplier has received payment in full for such goods. If any liens, encumbrances or charges are filed against Supplier's goods prior to full payment, Buyer shall discharge the liens, encumbrances or charges within (10) ten days and reimburse Supplier for expenses incurred defending its security interest. Supplier shall retain title in each item and/or good until fully paid. Full payment is herein defined to include all outstanding balances on the goods and/or services supplied and all finance charges that may have been incurred from the delivery date of such goods and/or services. Upon default, Supplier may recall and take possession of any items it sold to Buyer. Buyer at all times shall maintain insurance on all items sold equal to the contract value of the goods sold. Nothing in this paragraph shall be construed against the terms of this contract as F.O.B. Supplier's place of business. Shall it be construed against the F.O.B. terms, then the F.O.B. terms shall prevail over this clause, thereafter this clause shall be deemed null and void.

Statue of Limitations

Any action against Supplier shall be commenced within (90) ninety days after the cause of action has occurred.

Arbitration, Indemnification and Choice of Law

If both parties agree, disputes arising under this agreement shall be decided under procedure set by the American Arbitration Association. Buyer shall be liable for all costs of collection, fees, expenses, court costs and Supplier's actual attorney's fees and interest at the highest rate allowed by law. Buyer expressly agrees to indemnify and hold Supplier harmless from all charges and liability from any party relating to actions under this agreement. The rights and duties of the parties to this agreement and the construction and effect of these terms and conditions shall be governed by the laws of the state of Florida.

Failure to Object not a Waiver

The failure of Supplier to object to or to take affirmative action with respect to any conducts of Buyer which is in violation of the terms of this agreement shall not be construed as a waiver of the violation or breach or of any future violation, breach or wrongful conduct.

Unenforceable Terms

Any provision hereof prohibited or unenforceable under any applicable law of any jurisdiction shall as to such jurisdiction be ineffective without affecting any other provision of this Agreement. To the full extent, however, that the provisions of such applicable law may be waived, they are hereby waived at the end this Contract be deemed to be a valid and binding agreement enforceable in accordance with its terms.

Full Agreement

These terms and conditions represent the total agreement of the parties and all agreements entered into prior to or contemporaneously with the execution of this agreement, other than as provided herein, are excluded whether oral or in writing.

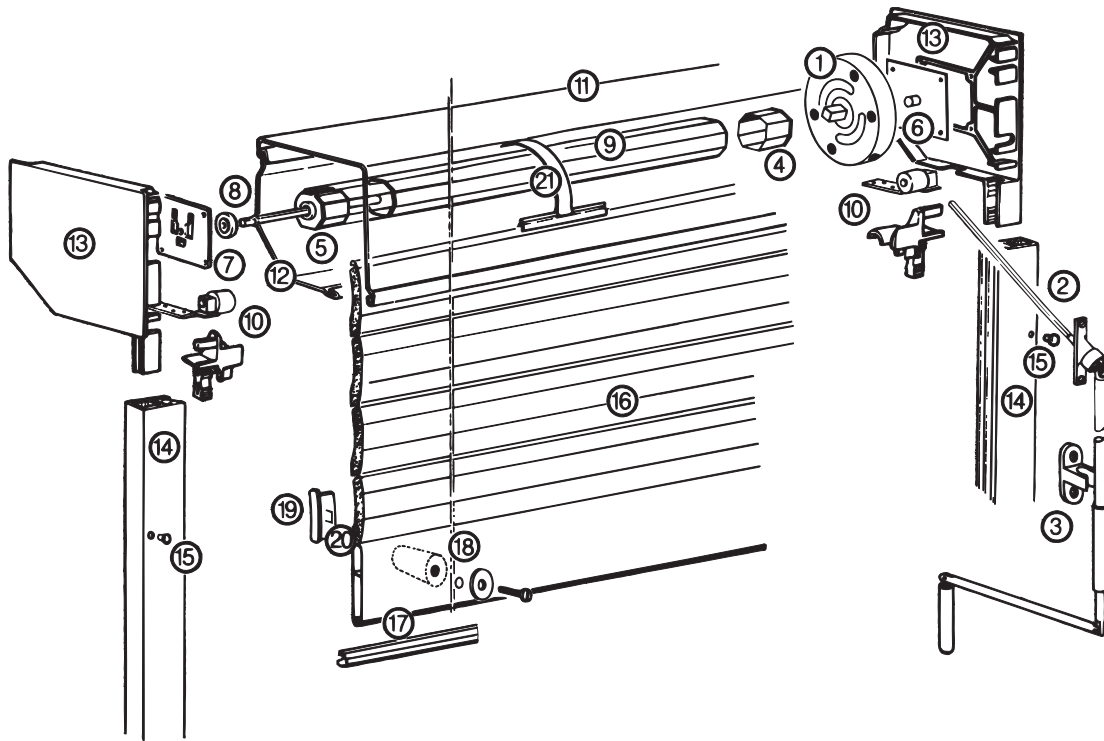

Features

Hand Crank Rollshutter System

- | | | |
|-----------------------|--|------------------------------------|
| 1. Gear | 8. Ball Bearing | 15. Plug Button |
| 2. Universal | 9. Octagonal Tube | 16. Aluminum/PVC Slat |
| 3. Crank Handle | 10. Entry Guide | 17. Base Slat |
| 4. Metal Gear Insert | 11. Housing (Top/Back) 4" - 10" | 18. Exterior Stop (Optional) |
| 5. Idler Insert (PVC) | 12. Housing (Front/Bottom) 4" - 10" (45° or 90°) | 19. Interior Nylon Stop (Optional) |
| 6. Gear Connector | 13. Side/End Cap (45° or 90°) | 20. Side Lock (Optional) |
| 7. Safety Plate | 14. Guide Rail | 21. Springlock Hanger |

PVC and Foam-Filled Slats

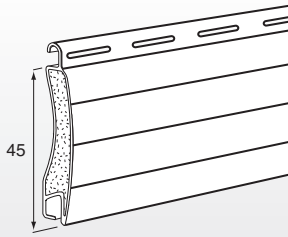

Features

Foam-Filled Slat Europe Mode | 40mm | Vented | Length: 19.8"

Stock No.	Color	Unit
1145-SL-EU-00	White	Feet
1145-SL-EU-05	Ivory	Feet
1145-SL-EU-07	Beige	Feet
1145-SL-EU-09	Brown	Feet
1145-SL-EU-10	Bronze	Feet

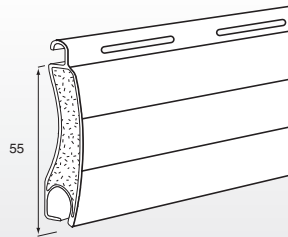

Features

Foam-Filled Slat Europe Mode | 55mm | Vented | Length: 19.8"

Stock No.	Color	Unit
1155-SL-EU-00	White	Feet
1155-SL-EU-05	Ivory	Feet
1155-SL-EU-07	Beige	Feet
1155-SL-EU-09	Brown	Feet
1155-SL-EU-10	Bronze	Feet

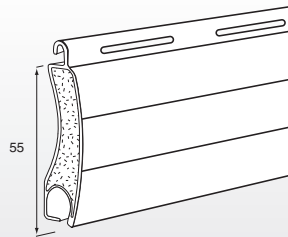

Features

PVC Slat Europe Mode | 55mm | Vented | Length: 19.8"

Stock No.	Color	Unit
1156-SV-EU-00	White	Feet

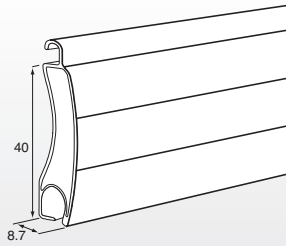

Features

Extruded Aluminum Slat | 40mm | Non-Vented | Length: 20.0"

Stock No.	Color	Unit
1240-SL-US-00	White	Feet
1240-SL-US-05	Ivory	Feet
1240-SL-US-07	Beige	Feet
1240-SL-US-09	Bronze	Feet
1240-SL-US-10	Mill Finish	Feet

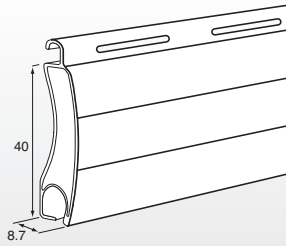

Features

Extruded Aluminum Slat | 40mm | Vented | Length: 20.0"

Stock No.	Color	Unit
1240-SV-US-00	White	Feet
1240-SV-US-05	Ivory	Feet
1240-SV-US-07	Beige	Feet
1240-SV-US-09	Bronze	Feet
1240-SV-US-10	Mill Finish	Feet

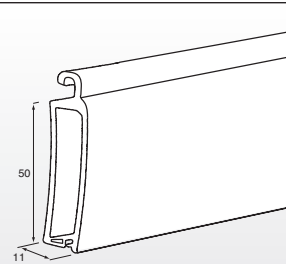

Features

Extruded Aluminum Slat | 50mm | Non-Vented | Powder-Coated | Length: 20.0"

Stock No.	Color	Unit
1250-SL-EU-00	White	Feet
1250-SL-EU-05	Ivory	Feet
1250-SL-EU-07	Beige	Feet
1250-SL-EU-10	Brown	Feet

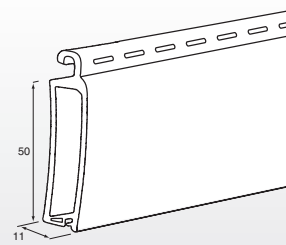

Features

Extruded Aluminum Slat | 50mm | Vented | Powder-Coated | Length: 20.0"

Stock No.	Color	Unit
1250-SV-EU-00	White	Feet
1250-SV-EU-05	Ivory	Feet
1250-SV-EU-07	Beige	Feet
1250-SV-EU-10	Bronze	Feet

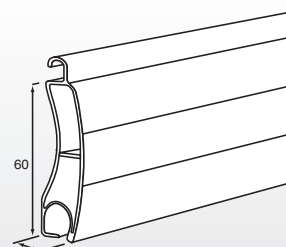

Features

Extruded Aluminum Slat | 60mm | Non-Vented | Powder-Coated | Length: 20.0"

Stock No.	Color	Unit
1260-SV-EU-00	White	Feet
1260-SV-EU-05	Ivory	Feet
1260-SV-EU-07	Beige	Feet
1260-SV-EU-10	Bronze	Feet

Extruded Aluminum Slats

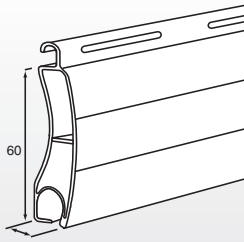

Features

Extruded Aluminum Slat | 60mm | Vented | Powder-Coated | Length: 20.0"

Stock No.	Color	Unit
1260-SV-EU-00	White	Feet
1260-SV-EU-05	Ivory	Feet
1260-SV-EU-07	Beige	Feet
1260-SV-EU-10	Bronze	Feet

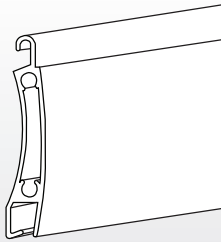

Features

RS Retention Slat | 40mm | Non-Vented | Length: 20.0"

Stock No.	Color	Unit
1240-RS-US-00	White	Feet
1240-RS-US-05	Ivory	Feet
1240-RS-US-07	Beige	Feet
1240-RS-US-10	Bronze	Feet

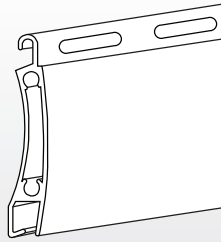

Features

RS Retention Slat | 40mm | Vented | Length: 20.0"

Stock No.	Color	Unit
1240-RS-VS-00	White	Feet
1240-RS-VS-05	Ivory	Feet
1240-RS-VS-07	Beige	Feet
1240-RS-VS-10	Bronze	Feet

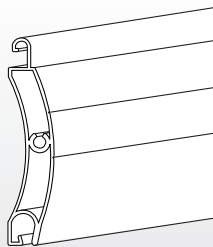

Features

RS Retention Slat | 61mm | Non-Vented | Length: 20.0"

Stock No.	Color	Unit
1260-RS-US-00	White	Feet
1260-RS-US-05	Ivory	Feet
1260-RS-US-07	Beige	Feet
1260-RS-US-10	Bronze	Feet

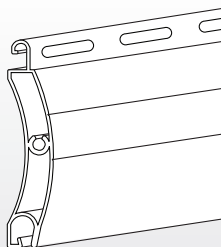

Features

RS Retention Slat | 61mm | Vented | Length: 20.0"

Stock No.	Color	Unit
1260-RS-VS-00	White	Feet
1260-RS-VS-05	Ivory	Feet
1260-RS-VS-07	Beige	Feet
1260-RS-VS-10	Bronze	Feet

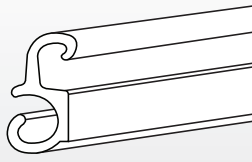

Features

Aluminum Joint | 40mm RS1000 Security Slat | Non-Vented | Powder-Coated | Length: 20.0"

Stock No.	Color	Unit
1245-JT-US-00	White	Feet

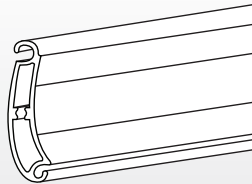

Features

Extruded Aluminum | 40mm RS1000 Security Slat | Non-Vented | Powder-Coated | Length: 20.0"

Stock No.	Color	Unit
1245-SL-US-00	White	Feet

Extruded Aluminum End Slats

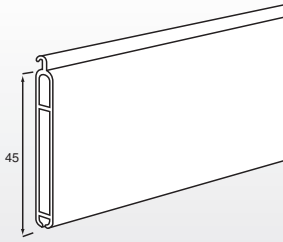

Features

End Slat | 40mm Slat | Non-Vented | Length: 20.0"

Stock No.	Color	Unit
1294-SL-US-00	White	Feet
1294-SL-US-05	Ivory	Feet
1294-SL-US-07	Beige	Feet
1294-SL-US-10	Bronze	Feet
1294-SL-US-98	Mill Finish	Feet

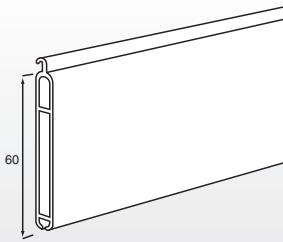

Features

End Slat | 50mm and 60mm Slat | Non-Vented | Length: 20.0"

Stock No.	Color	Unit
1296-SL-US-00	White	Feet
1296-SL-US-05	Ivory	Feet
1296-SL-US-06	Beige	Feet
1296-SL-US-10	Bronze	Feet
1296-SL-US-98	Mill Finish	Feet

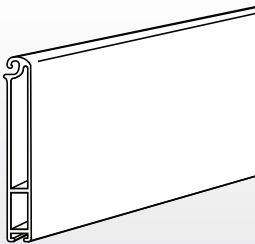

Features

End Slat | RS1000 | Non-Vented | Length: 20.0"

Stock No.	Color	Unit
1295-SL-US-00	White	Feet
1295-SL-US-05	Ivory	Feet
1295-SL-US-07	Beige	Feet
1295-SL-US-10	Bronze	Feet
1295-SL-US-98	Mill Finish	Feet

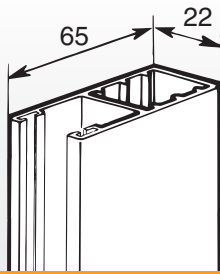

Features

Aluminum Side Rail | 7/8" x 2.5" | w/o Felp and Holes | Length: 20.0"

Stock No.	Color	Unit
1325-RA-MI-00	White	Feet
1325-RA-MI-05	Ivory	Feet
1325-RA-MI-07	Beige	Feet
1325-RA-MI-10	Bronze	Feet
1325-RA-MI-98	Mill Finish	Feet

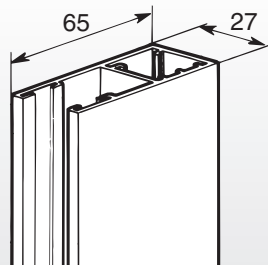

Features

Aluminum Side Rail | 1" x 2.5" | w/o Felp and Holes | Length: 20.0"

Stock No.	Color	Unit
1325-RA-MA-00	White	Feet
1325-RA-MA-05	Ivory	Feet
1325-RA-MA-07	Beige	Feet
1325-RA-MA-10	Bronze	Feet
1325-RA-MA-98	Mill Finish	Feet

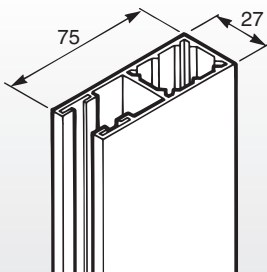

Features

Aluminum Side Rail | 1" x 3" | w/o Felp and Holes | Length: 20.0"

Stock No.	Color	Unit
1330-RA-US-00	White	Feet
1330-RA-US-05	Ivory	Feet
1330-RA-US-06	Beige	Feet
1330-RA-US-10	Bronze	Feet
1330-RA-US-98	Mill Finish	Feet

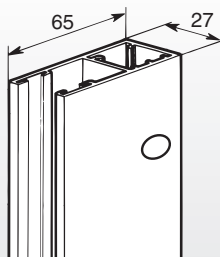

Features

Aluminum Side Rail | 7/8" x 2.5" | w/ Felp and Holes | Length: 20.0"

Stock No.	Color	Unit
1325-FH-MI-00	White	Feet
1325-FH-MI-05	Ivory	Feet
1325-FH-MI-07	Beige	Feet
1325-FH-MI-10	Brown	Feet

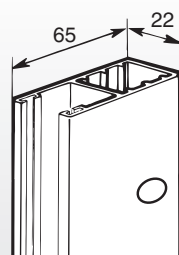

Features

Aluminum Side Rail | 1" x 2.5" | w/ Felp and Holes | Length: 20.0"

Stock No.	Color	Unit
1325-FH-MA-00	White	Feet
1325-FH-MA-05	Ivory	Feet
1325-FH-MA-07	Beige	Feet
1325-FH-MA-10	Brown	Feet

Extruded Aluminum Side Rails

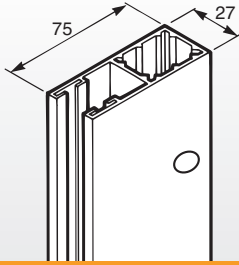

Features

Aluminum Side Rail | 1" x 3" | w/ Felp and Holes | Length: 20.0"

Stock No.	Color	Unit
1330-FH-US-00	White	Feet
1330-FH-US-05	Ivory	Feet
1330-FH-US-07	Beige	Feet
1330-FH-US-10	Bronze	Feet

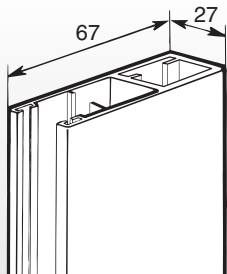

Features

RS Retention Mini Side Rail | 7/8" x 3" | w/o Felp and Holes | Length: 20.0"

Stock No.	Color	Unit
1326-RA-MI-00	White	Feet
1326-RA-MI-05	Ivory	Feet
1326-RA-MI-07	Beige	Feet
1326-RA-MI-10	Bronze	Feet

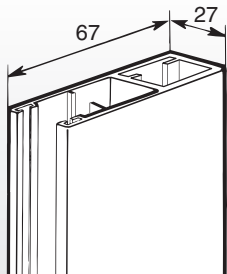

Features

RS Retention Maxi Side Rail | 1" x 3" | w/o Felp and Holes | Length: 20.0"

Stock No.	Color	Unit
1326-RA-EU-00	White	Feet
1326-RA-EU-05	Ivory	Feet
1326-RA-EU-07	Beige	Feet
1326-RA-EU-10	Bronze	Feet

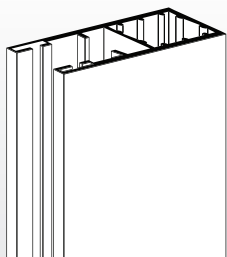

Features

RS Retention Big Pin Side Rail | 1" x 3.5" | w/o Felp and Holes | Length: 20.0"

Stock No.	Color	Unit
1327-RA-EU-00	White	Feet
1327-RA-EU-05	Ivory	Feet
1327-RA-EU-07	Beige	Feet
1327-RA-EU-10	Bronze	Feet

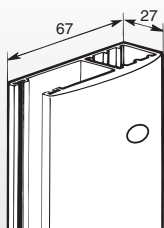

Features

RS Retention Mini Side Rail | 7/8" x 3" | w/ Felp and Holes (6" on center) | Length: 20.0"

Stock No.	Color	Unit
1326-MI-FH-00	White	Feet
1326-MI-FH-05	Ivory	Feet
1326-MI-FH-07	Beige	Feet
1326-MI-FH-10	Bronze	Feet

Extruded Aluminum Side Rails

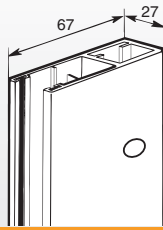

Features

RS Retention Maxi Side Rail | 1" x 3" | w/ Felp and Holes (6" on center) | Length: 20.0"

Stock No.	Color	Unit
1326-RA-FH-00	White	Feet
1326-RA-FH-05	Ivory	Feet
1326-RA-FH-07	Beige	Feet
1326-RA-FH-10	Bronze	Feet

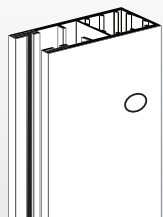

Features

RS Retention Big Pin Side Rail | 1" x 3.5" | w/ Felp and Holes (6" on center) | Length: 20.0"

Stock No.	Color	Unit
1327-RA-FH-00	White	Feet
1327-RA-FH-05	Ivory	Feet
1327-RA-FH-07	Beige	Feet
1327-RA-FH-10	Bronze	Feet

Aluminum Housings

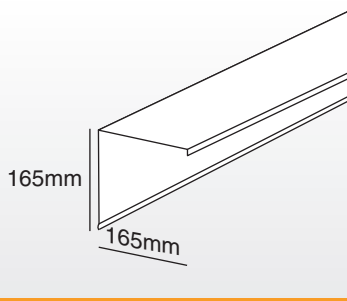

Features

Aluminum Housing | 165mm | Back | 6.5"

Stock No.	Color	Unit
1406-BK-90-00	White	Feet
1406-BK-90-05	Ivory	Feet
1406-BK-90-07	Beige	Feet
1406-BK-90-10	Bronze	Feet

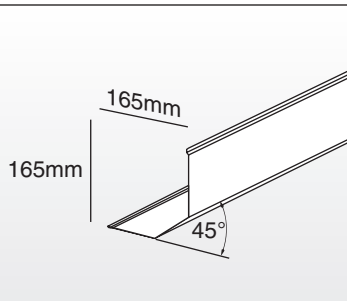

Features

Aluminum Housing | 165mm | 45° Front | 6.5"

Stock No.	Color	Unit
1406-FR-45-00	White	Feet
1406-FR-45-05	Ivory	Feet
1406-FR-45-07	Beige	Feet
1406-FR-45-10	Bronze	Feet

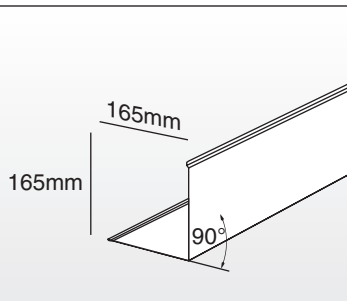

Features

Aluminum Housing | 165mm | 90° Front | 6.5"

Stock No.	Color	Unit
1406-FR-90-00	White	Feet
1406-FR-90-05	Ivory	Feet
1406-FR-90-07	Beige	Feet
1406-FR-90-10	Bronze	Feet

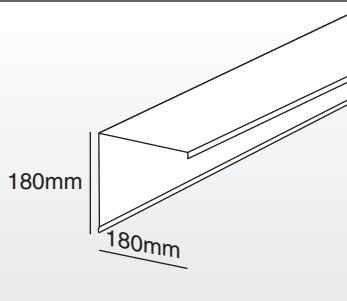

Features

Aluminum Housing | 180mm | Back | 7"

Stock No.	Color	Unit
1407-BK-90-00	White	Feet
1407-BK-90-05	Ivory	Feet
1407-BK-90-07	Beige	Feet
1407-BK-90-10	Bronze	Feet

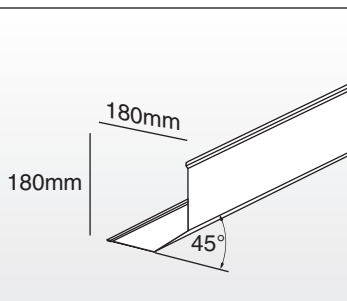

Features

Aluminum Housing | 180mm | 45° Front | 7"

Stock No.	Color	Unit
1407-FR-45-00	White	Feet
1407-FR-45-05	Ivory	Feet
1407-FR-45-07	Beige	Feet
1407-FR-45-10	Bronze	Feet

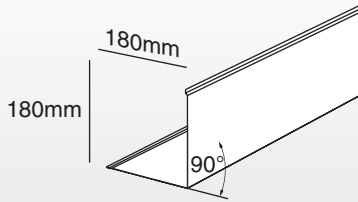

Features

Aluminum Housing | 180mm | 90° Front | 7"

Stock No.	Color	Unit
1407-FR-90-00	White	Feet
1407-FR-90-05	Ivory	Feet
1407-FR-90-07	Beige	Feet
1407-FR-90-10	Bronze	Feet

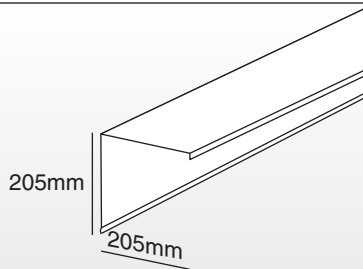

Features

Aluminum Housing | 205mm | Back | 8"

Stock No.	Color	Unit
1408-BK-90-00	White	Feet
1408-BK-90-05	Ivory	Feet
1408-BK-90-07	Beige	Feet
1408-BK-90-10	Brown	Feet

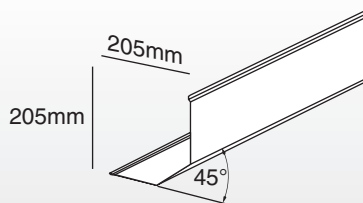

Features

Aluminum Housing | 205mm | 45° Front | 8"

Stock No.	Color	Unit
1408-FR-45-00	White	Feet
1408-FR-45-00	Ivory	Feet
1408-FR-45-00	Beige	Feet
1408-FR-45-00	Brown	Feet

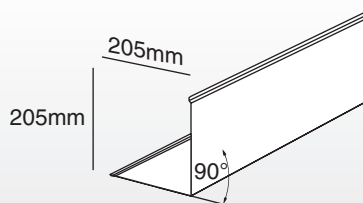

Features

Aluminum Housing | 205mm | 90° Front | 8"

Stock No.	Color	Unit
1408-FR-90-00	White	Feet
1408-FR-90-00	Ivory	Feet
1408-FR-90-00	Beige	Feet
1408-FR-90-00	Brown	Feet

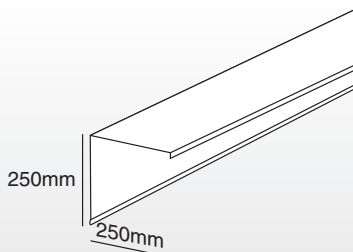

Features

Aluminum Housing | 250mm | Back | 10"

Stock No.	Color	Unit
1410-BK-90-00	White	Feet
1410-BK-90-00	Ivory	Feet
1410-BK-90-00	Beige	Feet
1410-BK-90-00	Brown	Feet

Aluminum Housings

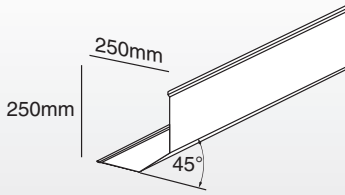

Features

Aluminum Housing | 250mm | 45° Front | 10"

Stock No.	Color	Unit
1410-FR-45-00	White	Feet
1410-FR-45-05	Ivory	Feet
1410-FR-45-07	Beige	Feet
1410-FR-45-10	Bronze	Feet

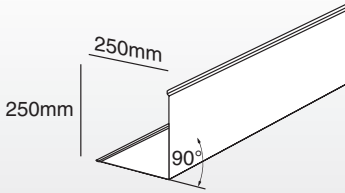

Features

Aluminum Housing | 250mm | 90° Front | 10"

Stock No.	Color	Unit
1410-FR-45-00	White	Feet
1410-FR-45-05	Ivory	Feet
1410-FR-45-07	Beige	Feet
1410-FR-45-10	Bronze	Feet

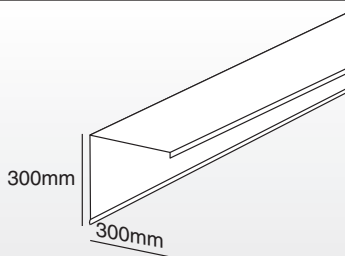

Features

Aluminum Housing | 300mm | Back | 12"

Stock No.	Color	Unit
1412-BK-90-00	White	Feet
1412-BK-90-05	Ivory	Feet
1412-BK-90-07	Beige	Feet
1412-BK-90-10	Bronze	Feet

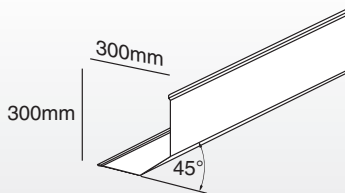

Features

Aluminum Housing | 300mm | 45° Front | 12"

Stock No.	Color	Unit
1412-FR-45-00	White	Feet
1412-FR-45-05	Ivory	Feet
1412-FR-45-07	Beige	Feet
1412-FR-45-10	Bronze	Feet

Did You Know?

Custom made housing sizes are available. Please call for more information and pricing. Have your specifications ready.

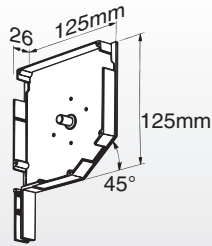

Features

Aluminum Side Cap | 5" | 45° Profile Powder-Coated (unless mill finish)

Stock No.	Color	Unit
1503-SC-45-00	White	Pair
1503-SC-45-05	Ivory	Pair
1503-SC-45-07	Beige	Pair
1503-SC-45-10	Bronze	Pair
1503-SC-45-98	Mill Finish	Pair

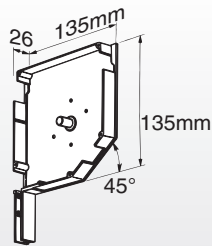

Features

Aluminum Side Cap | 5.5" | 45° Profile Powder-Coated (unless mill finish)

Stock No.	Color	Unit
1504-SC-45-00	White	Pair
1504-SC-45-05	Ivory	Pair
1504-SC-45-07	Beige	Pair
1504-SC-45-10	Bronze	Pair
1504-SC-45-98	Mill Finish	Pair

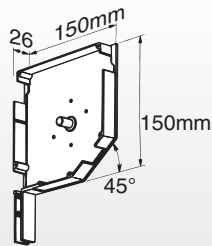

Features

Aluminum Side Cap | 6" | 45° Profile Powder-Coated (unless mill finish)

Stock No.	Color	Unit
1505-SC-45-00	White	Pair
1505-SC-45-05	Ivory	Pair
1505-SC-45-07	Beige	Pair
1505-SC-45-10	Bronze	Pair
1505-SC-45-98	Mill Finish	Pair

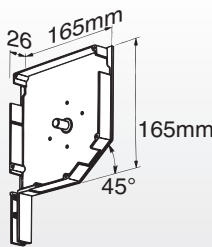

Features

Aluminum Side Cap | 6.5" | 45° Profile Powder-Coated (unless mill finish)

Stock No.	Color	Unit
1506-SC-45-00	White	Pair
1506-SC-45-05	Ivory	Pair
1506-SC-45-07	Beige	Pair
1506-SC-45-10	Bronze	Pair
1506-SC-45-98	Mill Finish	Pair

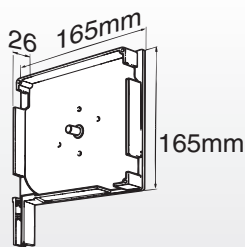

Features

Aluminum Side Cap | 6.5" | 90° Profile Powder-Coated (unless mill finish)

Stock No.	Color	Unit
1506-SC-90-00	White	Pair
1506-SC-90-05	Ivory	Pair
1506-SC-90-07	Beige	Pair
1506-SC-90-10	Bronze	Pair
1506-SC-90-98	Mill Finish	Pair

Aluminum Side Caps

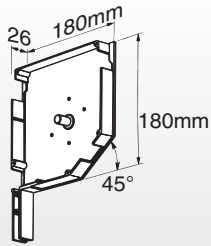

Features

Aluminum Side Cap | 7" | 45° Profile Powder-Coated (unless mill finish)

Stock No.	Color	Unit
1507-SC-45-00	White	Pair
1507-SC-45-05	Ivory	Pair
1507-SC-45-06	Beige	Pair
1507-SC-45-10	Bronze	Pair
1507-SC-45-98	Mill Finish	Pair

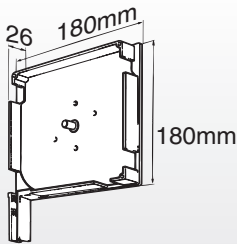

Features

Aluminum Side Cap | 7" | 90° Profile Powder-Coated (unless mill finish)

Stock No.	Color	Unit
1507-SC-90-00	White	Pair
1507-SC-90-05	Ivory	Pair
1507-SC-90-07	Beige	Pair
1507-SC-90-10	Bronze	Pair
1507-SC-90-98	Mill Finish	Pair

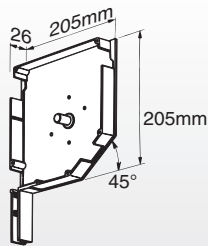

Features

Aluminum Side Cap | 8" | 45° Profile Powder-Coated (unless mill finish)

Stock No.	Color	Unit
1508-SC-45-00	White	Pair
1508-SC-45-05	Ivory	Pair
1508-SC-45-07	Beige	Pair
1508-SC-45-10	Bronze	Pair
1508-SC-45-98	Mill Finish	Pair
1508-SC-45-98BL		Pair

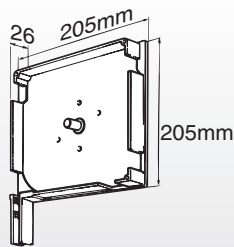

Features

Aluminum Side Cap | 8" | 90° Profile Powder-Coated (unless mill finish)

Stock No.	Color	Unit
1508-SC-90-00	White	Pair
1508-SC-90-05	Ivory	Pair
1508-SC-90-07	Beige	Pair
1508-SC-90-10	Bronze	Pair
1508-SC-90-98	Mill Finish	Pair

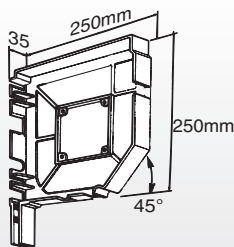

Features

Aluminum Side Cap | 10" | 45° Profile Powder-Coated (unless mill finish)

Stock No.	Color	Unit
1510-SC-45-00	White	Pair
1510-SC-45-05	Ivory	Pair
1510-SC-45-07	Beige	Pair
1510-SC-45-10	Bronze	Pair
1510-SC-45-98	Mill Finish	Pair

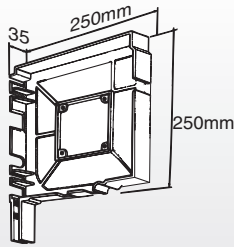

Features

Aluminum Side Cap | 10" | 90° Profile Powder-Coated*

Stock No.	Color	Unit
1510-SC-90-00	White	Pair
1510-SC-90-05	Ivory	Pair
1510-SC-90-07	Beige	Pair
1510-SC-90-10	Bronze	Pair
1510-SC-90-98	Mill Finish	Pair

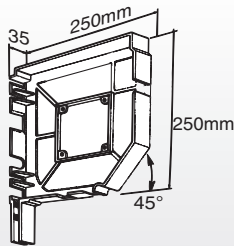

Features

Aluminum Side Cap | 10" | 45° Profile Small Pin Powder-Coated*

Stock No.	Color	Unit
1511-SC-45-00	White	Pair
1511-SC-45-05	Ivory	Pair
1511-SC-45-07	Beige	Pair
1511-SC-45-10	Bronze	Pair
1511-SC-45-98	Mill Finish	Pair

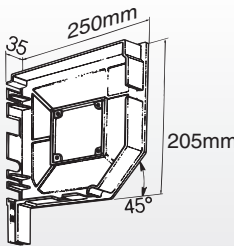

Features

Aluminum Side Cap | 12" | 45° Profile Powder-Coated*

Stock No.	Color	Unit
1512-SC-45-00	White	Pair
1512-SC-45-05	Ivory	Pair
1512-SC-45-07	Beige	Pair
1512-SC-45-10	Bronze	Pair
1512-SC-45-98	Mill Finish	Pair

* unless mill finish

Did You Know?

Custom made housing sizes are available. Please call for more information and pricing. Have your specifications ready.

Safety Plates

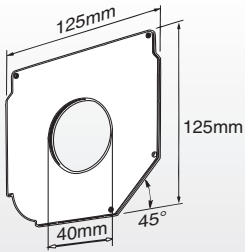

Features

Safety Plate | 5" | 45° Profile with 40mm Hole

Stock No.	Color	Unit
1703-SP-45-55	Mill Finish	Each

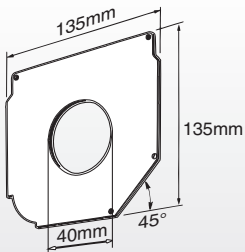

Features

Safety Plate | 5.5" | 45° Profile with 40mm Hole

Stock No.	Color	Unit
1704-SP-45-55	Mill Finish	Each

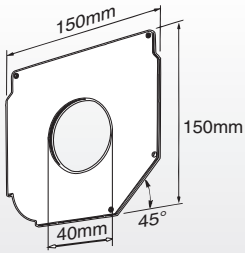

Features

Safety Plate | 6" | 45° Profile with 40mm Hole

Stock No.	Color	Unit
1705-SP-45-55	Mill Finish	Each

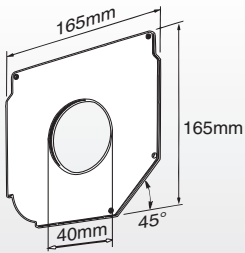

Features

Safety Plate | 6.5" | 45° Profile with 40mm Hole

Stock No.	Color	Unit
1706-SP-45-55	Mill Finish	Each

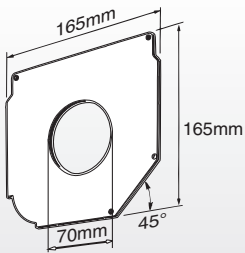

Features

Safety Plate | 6.5" | 45° Profile with 70mm Hole

Stock No.	Color	Unit
1706-SP-45-72	Mill Finish	Each

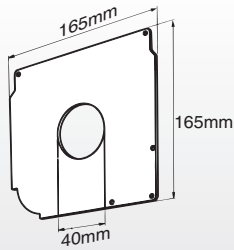

Features

Safety Plate | 6.5" | 90° Profile with 40mm Hole

Stock No.	Color	Unit
1706-SP-90-55	Mill Finish	Each

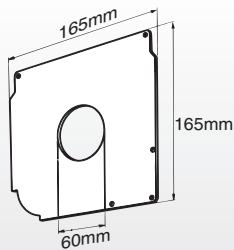

Features

Safety Plate | 6.5" | 90° Profile with 60mm Hole

Stock No.	Color	Unit
1706-SP-90-72	Mill Finish	Each

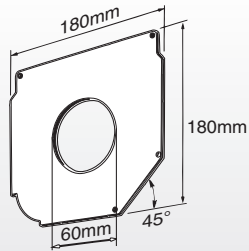

Features

Safety Plate | 7" | 45° Profile with 60mm Hole

Stock No.	Color	Unit
1707-SP-45-72	Mill Finish	Each

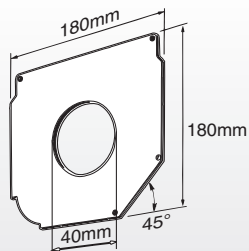

Features

Safety Plate | 7" | 45° Profile with 40mm Hole

Stock No.	Color	Unit
1707-SP-45-55	Mill Finish	Each

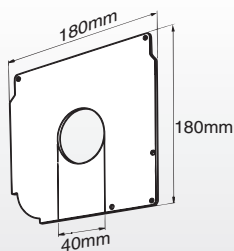

Features

Safety Plate | 7" | 90° Profile with 40mm Hole

Stock No.	Color	Unit
1707-SP-90-55	Mill Finish	Each

Safety Plates

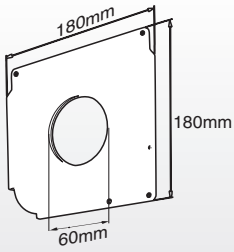

Features

Safety Plate | 7" | 90° Profile with 60mm Hole

Stock No.	Color	Unit
1707-SP-90-72	Mill Finish	Each

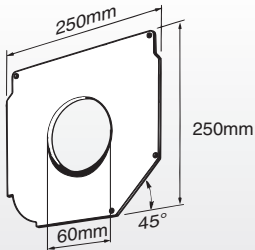

Features

Safety Plate | 8" | 45° Profile with 60mm Hole

Stock No.	Color	Unit
1708-SP-45-72	Mill Finish	Each

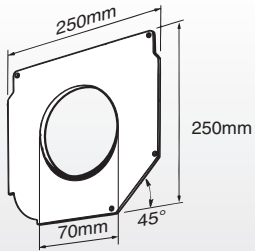

Features

Safety Plate | 8" | 45° Profile with 70mm Hole

Stock No.	Color	Unit
1708-SP-45-92	Mill Finish	Each

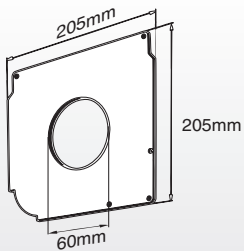

Features

Safety Plate | 8" | 90° Profile with 60mm Hole

Stock No.	Color	Unit
1708-SP-90-72	Mill Finish	Each

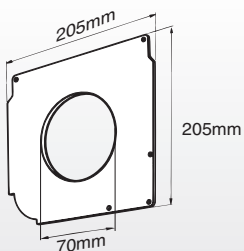

Features

Safety Plate | 8" | 90° Profile with 70mm Hole

Stock No.	Color	Unit
1708-SP-90-92	Mill Finish	Each

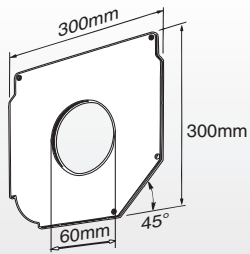

Features

Safety Plate | 10" | 45° Profile with 60mm Hole

Stock No.	Color	Unit
1710-SP-45-72	Mill Finish	Each

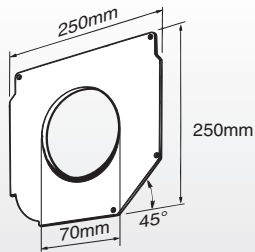

Features

Safety Plate | 10" | 45° Profile with 70mm Hole

Stock No.	Color	Unit
1710-SP-45-92	Mill Finish	Each

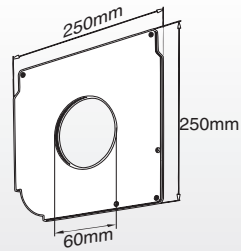

Features

Safety Plate | 10" | 90° Profile with 60mm Hole

Stock No.	Color	Unit
1710-SP-90-72	Mill Finish	Each

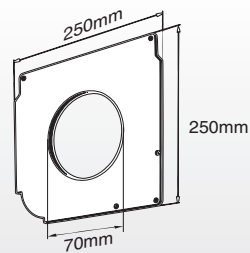

Features

Safety Plate | 10" | 90° Profile with 70mm Hole

Stock No.	Color	Unit
1710-SP-90-92	Mill Finish	Each

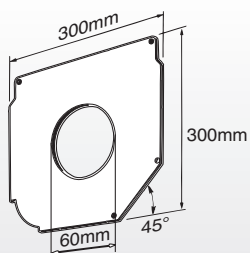

Features

Safety Plate | 12" | 45° Profile with 60mm Hole

Stock No.	Color	Unit
1712-SP-45-72	Mill Finish	Each

Safety Plates

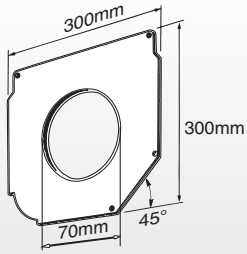

Features

Safety Plate | 12" | 45° Profile with 70mm Hole

Stock No.

1712-SP-45-92

Color

Mill Finish

Unit

Each

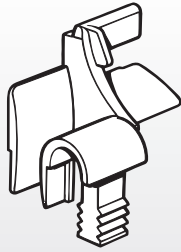

Features

Mini Entry Guide | 40mm

Stock No.

1800-EG-MI-00

Color

N/A

Unit

Each

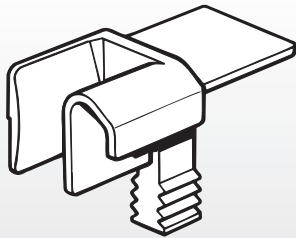

Features

Maxi Entry Guide | 60mm

Stock No.

1820-EG-MI-00

Color

N/A

Unit

Each

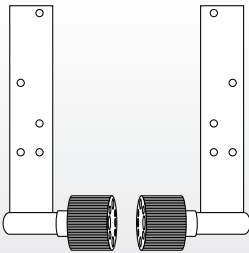

Features

Retention Entry Guide | w/ Roller Guide | 60mm

Stock No.

1820-EG-MR-00

Color

N/A

Unit

Each

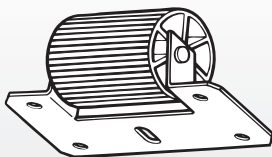

Features

Pressure Rollers

Stock No.

1830-MI-PR-RU

Color

N/A

Unit

Each

Slat Hangers

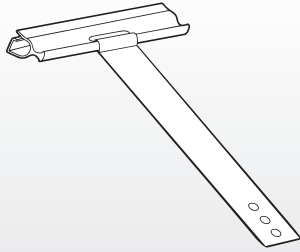

Features

Maxi Slat Hanger | Screw Mount

Stock No.	Color	Unit
1900-HA-MA-00	N/A	Each

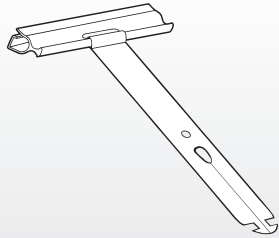

Features

Maxi Slat Hanger | Quick Mount

Stock No.	Color	Unit
1900-HA-MA-10	N/A	Each

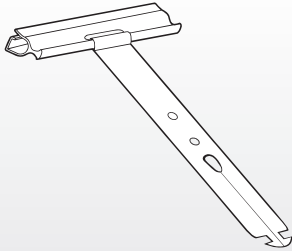

Features

Mini Slat Hanger | Quick Mount

Stock No.	Color	Unit
1900-HA-MI-10	N/A	Each

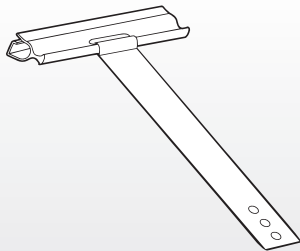

Features

Mini Slat Hanger | Screw Mount

Stock No.	Color	Unit
1900-HA-MI-00	N/A	Each

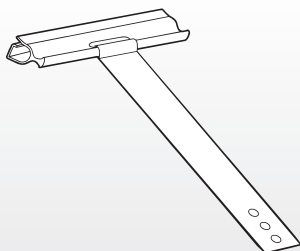

Features

RS1000 Slat Hanger | Screw Mount

Stock No.	Color	Unit
1900-HE-ME-00	N/A	Each

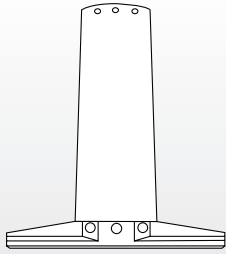

Features

High Security Hanger | Screw Mount

Stock No.	Color	Unit
SIRAL-GER-4250	N/A	Each

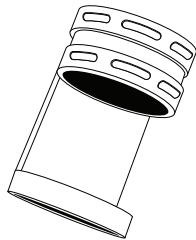

Features

Adapter Ring for Security Hanger | Quick Mount | 60mm

Stock No.	Color	Unit
SIRAL-GER-42561	N/A	Each

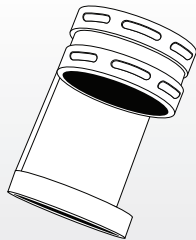

Features

Adapter Ring for Security Hanger | Quick Mount | 70mm

Stock No.	Color	Unit
SIRAL-GER-42570	N/A	Each

Roller Tubes

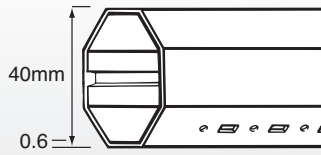

Features

Octagonal Tube | 40mm x 0.6mm | Galvanized Steel

Stock No.	Color	Unit
2040-TU-40-08	N/A	Feet

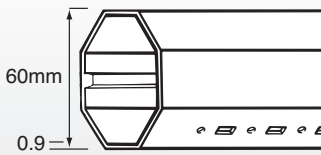

Features

Octagonal Tube | 60mm x 0.9mm | Galvanized Steel

Stock No.	Color	Unit
2060-TU-60-10	N/A	Feet

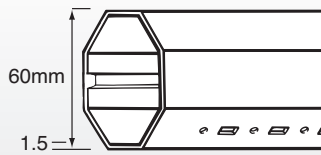

Features

Octagonal Tube | 60mm x 1.5mm | Aluminum

Stock No.	Color	Unit
2060-TU-60-15	N/A	Feet

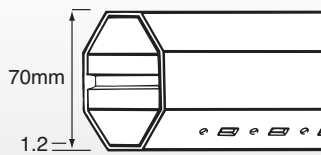

Features

Octagonal Tube | 70mm x 1.2mm | Galvanized Steel

Stock No.	Color	Unit
2070-TU-70-12	N/A	Feet

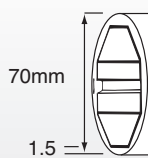

Features

Round Tube | 70mm | Octagonal Inside | Aluminum

Stock No.	Color	Unit
2070-TU-70-22	N/A	Feet

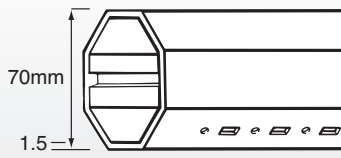

Features

Octagonal Tube | 70mm x 1.5mm | Aluminum

Stock No.	Color	Unit
2070-TU-70-32	N/A	Feet

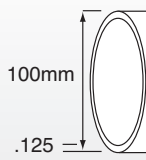

Features

Round Tube | 100mm | Aluminum

Stock No.	Color	Unit
2100-TU-10-AL	N/A	Feet

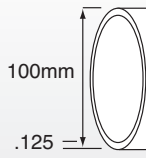

Features

Round Tube | 100mm | Steel

Stock No.	Color	Unit
2100-TU-10-ST	N/A	Feet

Idler Caps

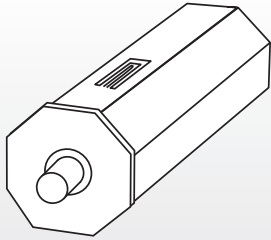

Features

PVC Cap with Pivot | 40mm

Stock No.	Color	Unit
2140-IC-80-10	N/A	Each

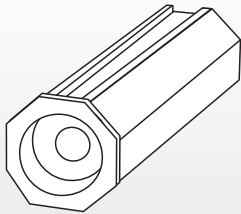

Features

PVC Idler Cap | 40mm

Stock No.	Color	Unit
2140-IC-80-28	N/A	Each

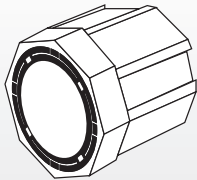

Features

PVC Cap | 60mm | for 42mm Ball Bearing

Stock No.	Color	Unit
2160-IC-55-42	N/A	Each

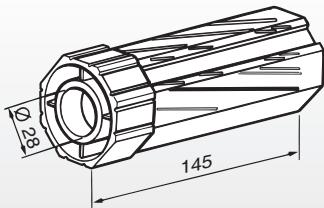

Features

PVC Idler Cap | 60mm

Stock No.	Color	Unit
2160-IC-X4-28	N/A	Each

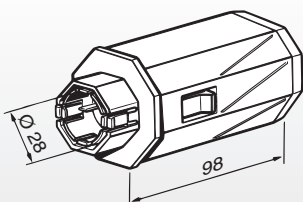

Features

Idler Telescopic Cap | 60mm

Stock No.	Color	Unit
2160-TC-98-28	N/A	Each

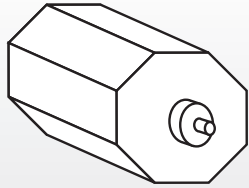

Features

Aluminum Cap | 60mm | with Pivot

Stock No.	Color	Unit
2160-IC-42-12	N/A	Each

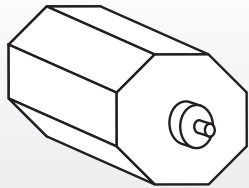

Features

Galvanized Steel Cap | 60mm | with Pivot

Stock No.	Color	Unit
2160-IC-40-12	N/A	Each

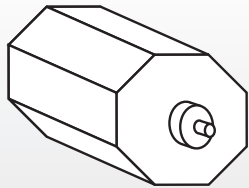

Features

Aluminum Cap | 70mm | with Pivot

Stock No.	Color	Unit
2170-IC-42-12	N/A	Each

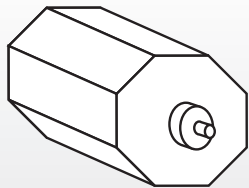

Features

Galvanized Steel Cap | 70mm | with Pivot

Stock No.	Color	Unit
2170-IC-40-12	N/A	Each

Shaft Couplers and Shaft Caps

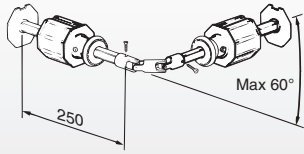

Features

Shaft Coupler Bow | PVC | 60mm

Stock No.	Color	Unit
2184-SC-60-BW	N/A	Each

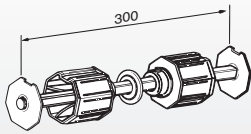

Features

Shaft Coupler Adjustable | PVC | 60mm

Stock No.	Color	Unit
2185-SC-60-42	N/A	Each

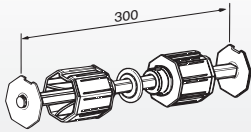

Features

Shaft Coupler Adjustable | PVC | 70mm

Stock No.	Color	Unit
2185-SC-70-42	N/A	Each

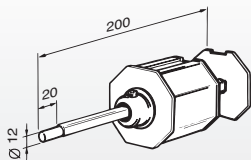

Features

Shaft Cap Adjustable | PVC | 60mm

Stock No.	Color	Unit
2186-SC-60-12	N/A	Each

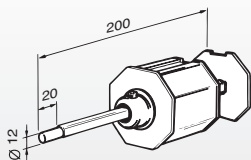

Features

Aluminum Shaft Cap | 60mm

Stock No.	Color	Unit
2187-SC-60-12	N/A	Each

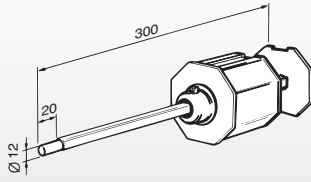

Features

Shaft Cap Adjustable | PVC | 70mm

Stock No.	Color	Unit
2186-SC-70-12	N/A	Each

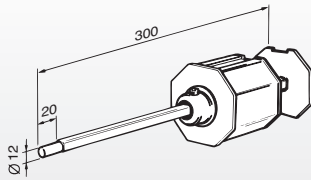

Features

Aluminum Shaft Cap | 70mm

Stock No.	Color	Unit
2187-SC-70-12	N/A	Each

Adapter Rings

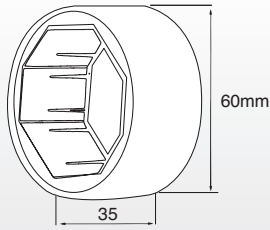

Features

PVC Adapter Ring | Octagonal | 60mm

Stock No.	Color	Unit
2175-AR-60-00	N/A	Each

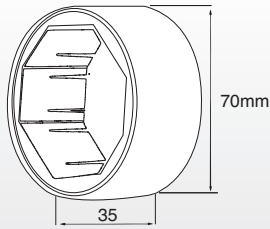

Features

PVC Adapter Ring | Octagonal | 70mm

Stock No.	Color	Unit
2175-AR-70-00	N/A	Each

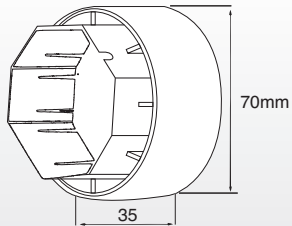

Features

PVC Adapter Ring | Octagonal | 70mm to 101mm

Stock No.	Color	Unit
2175-AR-70-10	N/A	Each

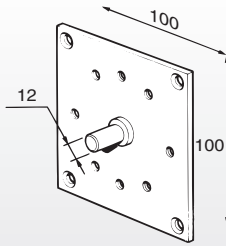

Features

Idler Bracket | 100 x 100

Stock No.	Color	Unit
2190-IS-00-MA	N/A	Each

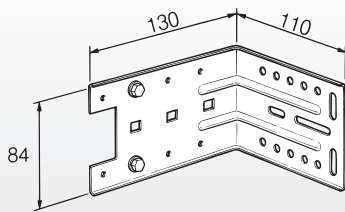

Features

Galvanized Steel Bracket | w/ Threaded Holes

Stock No.	Color	Unit
2191-UB-TH-00	N/A	Each

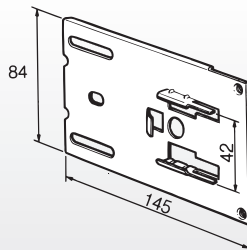

Features

Bracket Plate | 42mm Bearing

Stock No.	Color	Unit
2192-UP-VB-42	N/A	Each

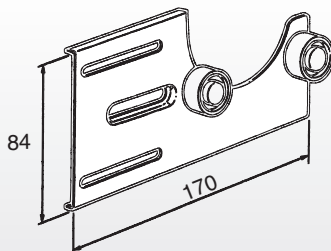

Features

Galvanized Steel Intermediate Roller Bracket | For Split Units

Stock No.	Color	Unit
2193-IB-RO-AS	N/A	Each

Ball Bearings and Bearing Holders

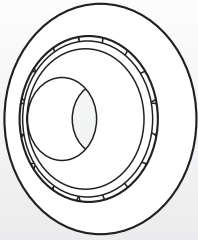

Features

Ball Bearing | Nylon | 42mm

Stock No.	Color	Unit
2242-BB-42-00	N/A	Each

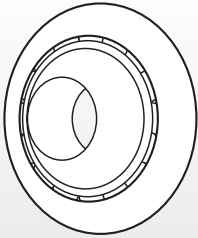

Features

Ball Bearing | Stainless Steel | 42mm

Stock No.	Color	Unit
2242-BB-42-01	N/A	Each

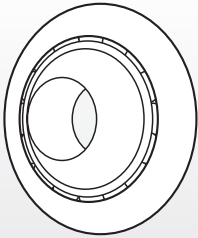

Features

Ball Bearing | Stainless Steel | Flat | 42mm

Stock No.	Color	Unit
2242-BB-42-02	N/A	Each

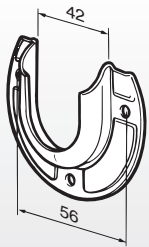

Features

Ball Bearing Holder | 3 Holes | For 42mm Ball Bearing

Stock No.	Color	Unit
2242-BH-42-03	N/A	Each

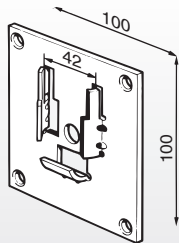

Features

Ball Bearing Plate | 100 x 100 | For 42mm Ball Bearing

Stock No.	Color	Unit
2242-BP-42-04	N/A	Each

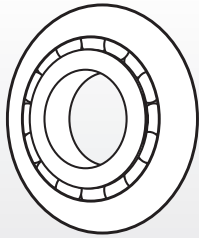

Features

Ball Bearing | Nylon | 28mm

Stock No.	Color	Unit
2228-BB-28-00	N/A	Each

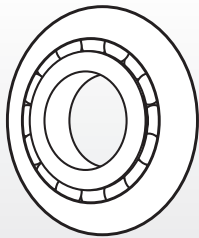

Features

Ball Bearing | Stainless Steel | 28mm

Stock No.	Color	Unit
2228-BB-28-01	N/A	Each

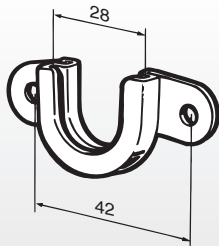

Features

Ball Bearing Holder | 2 Holes | For 28mm Ball Bearing

Stock No.	Color	Unit
2228-BH-28-02	N/A	Each

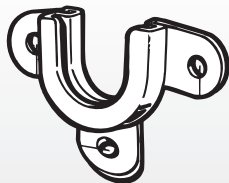

Features

Ball Bearing Holder | 3 Holes | For 28mm Ball Bearing

Stock No.	Color	Unit
2228-BH-28-03	N/A	Each

Reduction Gears and Inserts

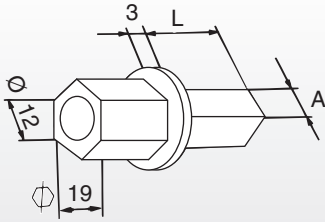

Features

Hexagonal Gear | Pivot

Stock No.

2300-GE-00-00

Color

N/A

Unit

Each

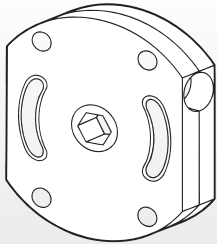

Features

Oval Gear | 1:5

Stock No.

2305-GE-01-05

Color

N/A

Unit

Each

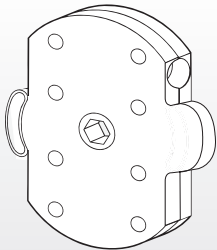

Features

Oval Gear | 1:11 | PVC

Stock No.

2308-GE-01-11

Color

N/A

Unit

Each

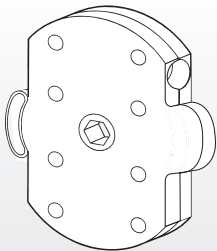

Features

Oval Gear | 1:11 | ZAMAK

Stock No.

2308-GE-02-11

Color

N/A

Unit

Each

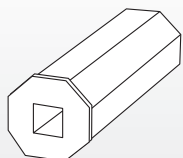

Features

PVC Gear Insert | 40mm

Stock No.

2440-GI-40-76

Color

N/A

Unit

Each

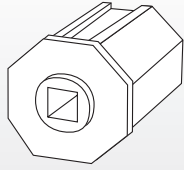

Features

Aluminum Gear Insert | 60mm

Stock No.

2460-GI-60-50

Color

N/A

Unit

Each

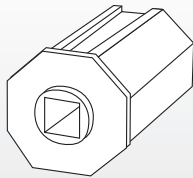

Features

PVC Gear Insert | 60mm

Stock No.

2460-GI-60-55

Color

N/A

Unit

Each

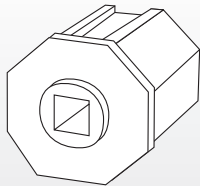

Features

Aluminum Gear Insert | 70mm

Stock No.

2470-GI-70-50

Color

N/A

Unit

Each

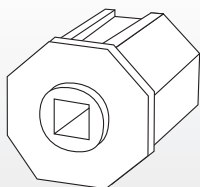

Features

PVC Gear Insert | 70mm

Stock No.

2470-GI-70-51

Color

N/A

Unit

Each

Universals and Handles

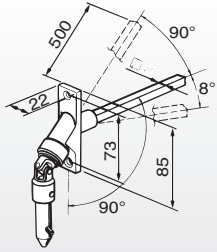

Features

Universal 2 Hole | Nickel | w/Pivot | 8mm Square Shaft

Stock No.	Color	Unit
2530-UC-02-NI	N/A	Each

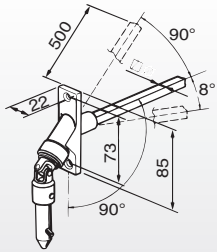

Features

Universal 2 Hole | Stainless Steel | w/Pivot | 8mm Square Shaft

Stock No.	Color	Unit
2530-UC-02-SS	N/A	Each

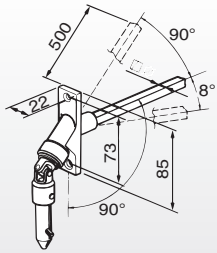

Features

Universal 2 Hole | Stainless Steel | w/Pivot | 8mm Square Shaft | Geiger

Stock No.	Color	Unit
2530-UG-02-SS	N/A	Each

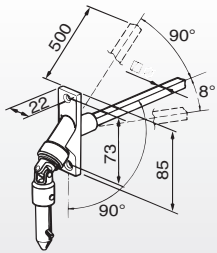

Features

Universal 2 Hole | Hardened Aluminum | w/Plastic Cover | 8mm Square Shaft

Stock No.	Color	Unit
2530-UG-02-SP	N/A	Each

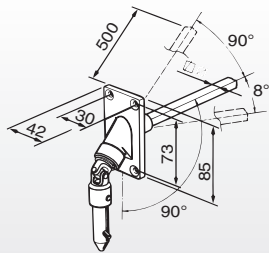

Features

Universal 4 Hole | Nickel | w/Pivot | 8mm Square Shaft

Stock No.	Color	Unit
2530-UC-04-NI	N/A	Each

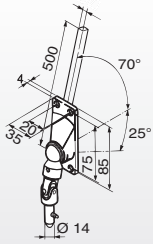

Features

Universal 4 Hole | Stainless Steel | w/Pivot | 8mm Square Shaft

Stock No.	Color	Unit
2530-UC-04-SS	N/A	Each

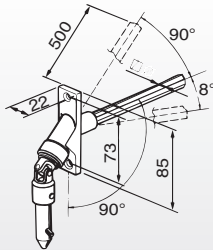

Features

Universal 2 Hole | Nickel | w/Pivot | 7mm Hex Shaft

Stock No.	Color	Unit
2537-UC-02-NI	N/A	Each

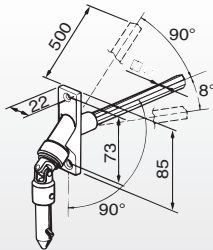

Features

Universal 2 Hole | Stainless Steel | w/Pivot | 7mm Hex Shaft

Stock No.	Color	Unit
2537-UC-02-SS	N/A	Each

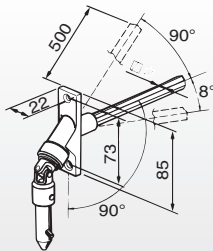

Features

Universal 2 Hole | Stainless Steel | w/Pivot | 7mm Hex Shaft | Geiger

Stock No.	Color	Unit
2537-UG-02-SS	N/A	Each

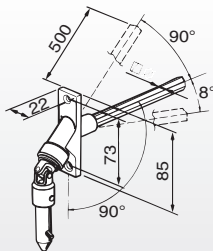

Features

Universal 2 Hole | Stainless Steel | w/Plastic Cover | 7mm Hex Shaft | Geiger

Stock No.	Color	Unit
2537-UG-02-SP	N/A	Each

Universals and Handles

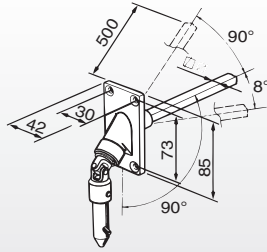

Features

Universal 4 Hole | Nickel | w/Pivot | 7mm Hex Shaft

Stock No.	Color	Unit
2537-UC-04-NI	N/A	Each

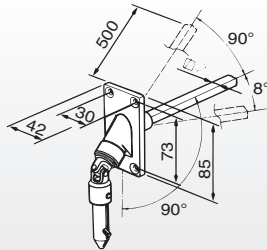

Features

Universal 4 Hole | Stainless Steel | w/Pivot | 7mm Hex Shaft

Stock No.	Color	Unit
2537-UC-04-SS	N/A	Each

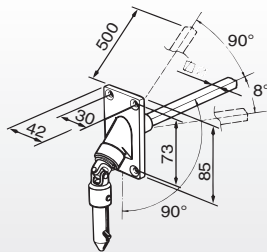

Features

Universal 4 Hole | Stainless Steel | w/Pivot | 7mm Hex Shaft | Geiger

Stock No.	Color	Unit
2537-UG-04-SS	N/A	Each

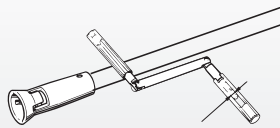

Features

Crank Handle - Nickel | Aluminum Pipe w/ Bell*

Stock No.	Color	Unit
2540-HA-NI-OB	N/A	Each

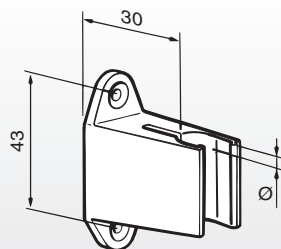

Features

Crank Handle Holder

Stock No.	Color	Unit
2545-HH-02-00	White	Each
2545-HH-02-01	Grey	Each

*Custom length's available

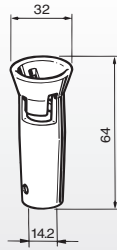

Features

O'Bell | Chrome | 14.2 mm

Stock No.	Color	Unit
2590-OB-00-14	N/A	Each

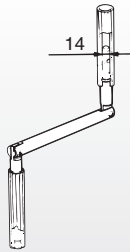

Features

Nickel Handle for Hand Crank

Stock No.	Color	Unit
2592-HA-NI-00	N/A	Each



Features

Aluminum Anodized Pipe for Crank Handle

Stock No.	Color	Unit
2595-AP-ST-08	N/A	Feet

Slat Locks



Features

Slat Lock | Extruded Slat | 40mm

Stock No.	Color	Unit
3400-LO-40-00	Black	Pair



Features

Slat Lock | Extruded Slat | 50mm

Stock No.	Color	Unit
3400-LO-50-00	Black	Pair



Features

Slat Lock | Extruded Slat | 60mm

Stock No.	Color	Unit
3400-LO-60-00	Black	Pair



Features

Slat Lock | Extruded Slat | RS1000

Stock No.	Color	Unit
3400-LO-45-00	Black	Pair



Features

Slat Lock | Foam-Filled Slat | 55mm

Stock No.	Color	Unit
3300-LO-50-00	Black	Pair



Features

Slat Lock | Hard Foam-Filled Slat | 55mm

Stock No.	Color	Unit
3600-LO-55-00	Black	Pair



Features

Slat Lock | Foam-Filled Slat | 45mm

Stock No.	Color	Unit
3200-LO-40-00	Black	Pair

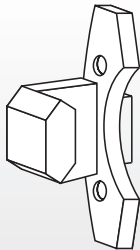

Features

Slat Lock | Extruded Retention Slat | 40mm

Stock No.	Color	Unit
3500-LO-40-00	White	Pair



Features

Slat Lock | Extruded Retention Slat | 61mm

Stock No.	Color	Unit
3500-LO-60-00	White	Pair

General Parts

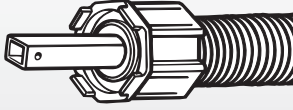

Features

Spring Assist | 15kg | 40mm

Stock No.	Color	Unit
2630-MI-SP-40	N/A	Each

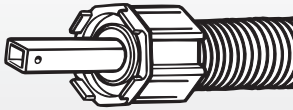

Features

Spring Assist | 24kg | 60mm

Stock No.	Color	Unit
2630-MI-SP-60	N/A	Each

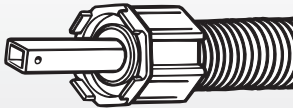

Features

Spring Assist | 34kg | 60mm

Stock No.	Color	Unit
2630-MA-SP-60	N/A	Each

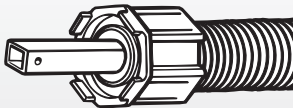

Features

Spring Assist | 32kg | 70mm

Stock No.	Color	Unit
2631-MI-SP-70	N/A	Each

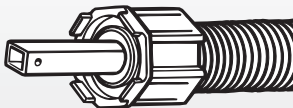

Features

Spring Assist | 56kg | 70mm

Stock No.	Color	Unit
2631-MA-SP-70	N/A	Each

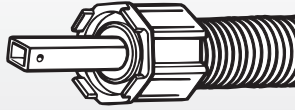

Features

Spring Assist | 76kg | 70mm

Stock No.	Color	Unit
2630-UM-SP-70	N/A	Each

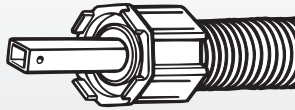

Features

Spring Assist | 100kg | 70mm

Stock No.	Color	Unit
2631-UM-SP-70	N/A	Each

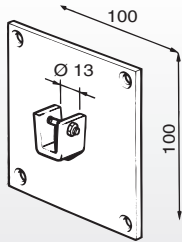

Features

Spring Support Plate

Stock No.	Color	Unit
2632-MI-SP-PL	N/A	Each

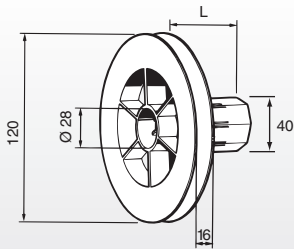

Features

PVC Pulley | 120mm | 40mm Req. | 28mm Ball Bearing

Stock No.	Color	Unit
2640-PU-12-28	N/A	Each

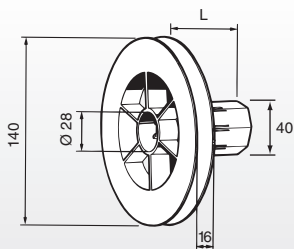

Features

PVC Pulley | 140mm | 40mm Req. | 28mm Ball Bearing

Stock No.	Color	Unit
2640-PU-14-28	N/A	Each

General Parts

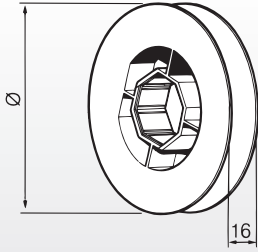

Features

PVC Pulley | 150mm | 60mm

Stock No.	Color	Unit
2660-PU-15-00	N/A	Each

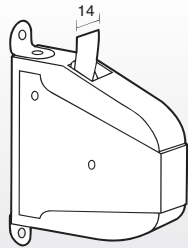

Features

Mini Recoil Box | Metal Wall Support

Stock No.	Color	Unit
2710-RB-ME-00	White	Each
2710-RB-ME-05	Ivory	Each
2710-RB-ME-10	Bronze	Each

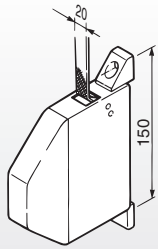

Features

Maxi Recoil Box | PVC Wall Support

Stock No.	Color	Unit
2740-RB-PL-00	White	Each

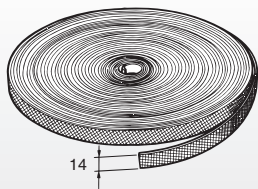

Features

Mini Tape | 14mm

Stock No.	Color	Unit
2750-TA-14-00	White	Each
2750-TA-14-05	Ivory	Each

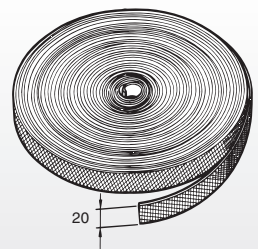

Features

Mini Tape | 20mm

Stock No.	Color	Unit
2750-TA-20-05	Ivory	Each

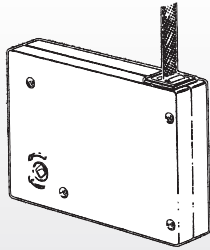

Features

B-08 Strap Winch | 1.3

Stock No.	Color	Unit
2820-SW-MI-00	N/A	Each

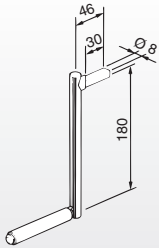

Features

M-02 | Nickel Handle

Stock No.	Color	Unit
2830-WH-00-00	N/A	Each

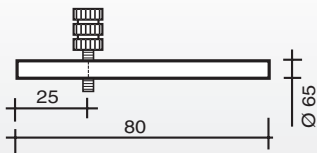

Features

Security Side Bolt Lock for End Slat

Stock No.	Color	Unit
3000-MI-LO-87	N/A	Each

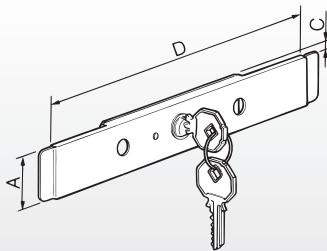

Features

Security Cylinder Lock for End Slat

Stock No.	Color	Unit
3000-SE-LO-00	N/A	Each

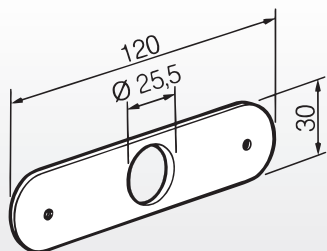

Features

Covering Plate for Security Lock

Stock No.	Color	Unit
3000-SE-PL-00	N/A	Each

General Parts



Features

Plug Button I 1/2"

Stock No.	Color	Unit
4125-BU-12-00	White	Each
4125-BU-12-05	Ivory	Each
4125-BU-12-07	Beige	Each
4125-BU-12-10	Bronze	Each



Features

Plug Button I 5/8"

Stock No.	Color	Unit
4125-BU-15-00	White	Each

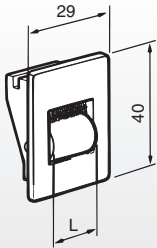

Features

Mini Tape Guide

Stock No.	Color	Unit
2790-SG-BM-00	White	Each
2790-SG-BM-05	Ivory	Each
2790-SG-BM-10	Bronze	Each

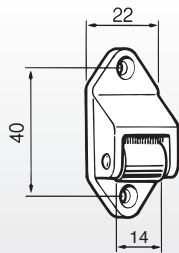

Features

Exterior Mini Tape Guide

Stock No.	Color	Unit
2790-SG-WM-00	White	Each
2790-SG-WM-05	Ivory	Each
2790-SG-WM-10	Bronze	Each

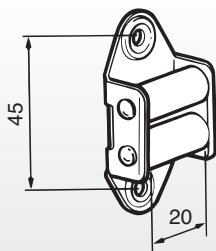

Features

Metal Mini Tape Guide w/Double Nylon Rollers for Wall Mount

Stock No.	Color	Unit
2790-SG-WM-98	Mill Finish	Each

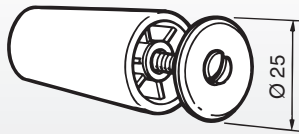

Features

Conical Stop for Bottom Slats

Stock No.	Color	Unit
3000-PS-00-00	White	Each
3000-PS-00-01	Ivory	Each
3000-PS-00-05	Bronze	Each
3000-PS-00-15	Brown	Each



Features

Large Weather Strip Felt

Stock No.	Color	Unit
4210-MI-LG-FE	Black	Feet



Features

Small Weather Strip Felt

Stock No.	Color	Unit
4210-MI-SM-FE	Grey	Feet

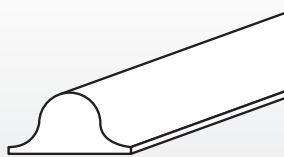

Features

Rubber for Side Rails | RS1000

Stock No.	Color	Unit
4219-MI-SR-RU	Black	Feet



Features

Rubber for End Slats | 40mm, 50mm and 60mm

Stock No.	Color	Unit
4121-MI-RA-RU	Black	Feet

General Parts

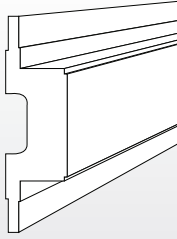

Features

Rubber for Retention Side Rails | Large

Stock No.	Color	Unit
4131-MI-RA-RU	N/A	Each

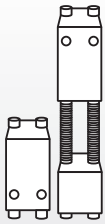

Features

2x2 Storm Bar Set | 2 Pieces

Stock No.	Color	Unit
STORM-BAR-2X2S	N/A	Set

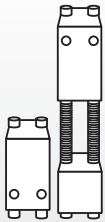

Features

2x3 Storm Bar Set | 2 Pieces

Stock No.	Color	Unit
STORM-BAR-2X3S	N/A	Set

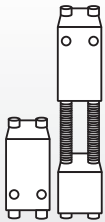

Features

2x4 Storm Bar Set | 2 Pieces

Stock No.	Color	Unit
STORM-BAR-2X4S	N/A	Set

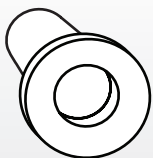

Features

Plastic Caps for Storm Bars

Stock No.	Color	Unit
STORM-BAR-P-CA	N/A	Each

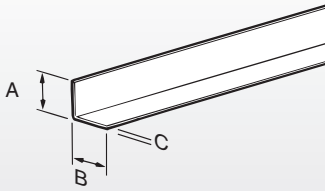

Features

Aluminum Angles | Length: 20'

A x B x C	Stock No.	Color	Unit
1.5 x 1.5 x .125	5010-LA-18-00	White	Feet
1.5 x 1.5 x .125	5010-LA-18-05	Ivory	Feet
1.5 x 1.5 x .125	5010-LA-18-07	Beige	Feet
1.5 x 1.5 x .125	5010-LA-18-10	Bronze	Feet
1.5 x 1.5 x .125	5010-LA-18-98	Mill	Feet

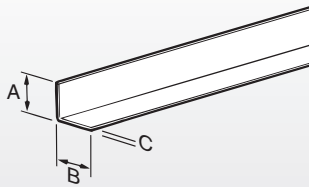

Features

Aluminum Angles | Length: 20'

A x B x C	Stock No.	Color	Unit
1 x 1 x .125	5011-LA-18-00	White	Feet
1 x 1 x .125	5011-LA-18-05	Ivory	Feet
1 x 1 x .125	5011-LA-18-07	Beige	Feet
1 x 1 x .125	5011-LA-18-10	Bronze	Feet
1 x 1 x .125	5011-LA-18-98	Mill	Feet

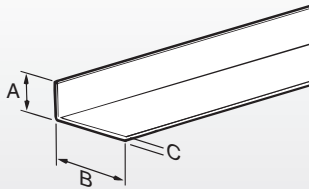

Features

Aluminum Angles | Length: 20'

A x B x C	Stock No.	Color	Unit
1 x 2 x .0625	5012-LA-16-98	Mill	Feet

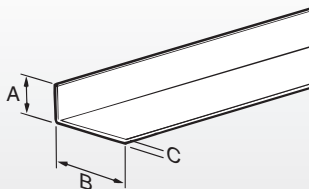

Features

Aluminum Angles | Length: 20'

A x B x C	Stock No.	Color	Unit
1 x 2 x .125	5012-LA-18-00	White	Feet
1 x 2 x .125	5012-LA-18-05	Ivory	Feet
1 x 2 x .125	5012-LA-18-07	Beige	Feet
1 x 2 x .125	5012-LA-18-10	Bronze	Feet
1 x 2 x .125	5012-LA-18-98	Mill	Feet

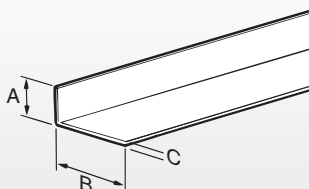

Features

Aluminum Angles | Length: 20'

A x B x C	Stock No.	Color	Unit
1 x 2 x .093	5012-LA-32-00	White	Feet
1 x 2 x .093	5012-LA-32-05	Ivory	Feet
1 x 2 x .093	5012-LA-32-07	Beige	Feet
1 x 2 x .093	5012-LA-32-10	Bronze	Feet
1 x 2 x .093	5012-LA-32-98	Mill	Feet

Extruded Aluminum Angles

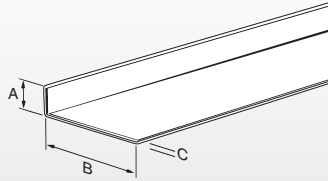

Features

Aluminum Angles | Length: 20'

A x B x C	Stock No.	Color	Unit
1 x 3 x .125	5013-LA-18-00	White	Feet
1 x 3 x .125	5013-LA-18-05	Ivory	Feet
1 x 3 x .125	5013-LA-18-07	Beige	Feet
1 x 3 x .125	5013-LA-18-10	Bronze	Feet
1 x 3 x .125	5013-LA-18-98	Mill	Feet

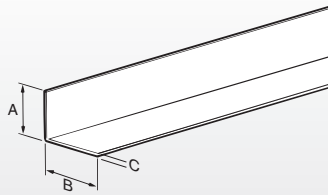

Features

Aluminum Angles | Length: 20'

A x B x C	Stock No.	Color	Unit
2 x 2 x .125	5022-LA-18-00	White	Feet
2 x 2 x .125	5022-LA-18-05	Ivory	Feet
2 x 2 x .125	5022-LA-18-07	Beige	Feet
2 x 2 x .125	5022-LA-18-10	Bronze	Feet
2 x 2 x .125	5022-LA-18-98	Mill	Feet

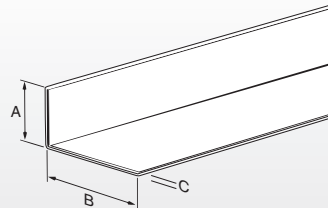

Features

Aluminum Angles | Length: 20'

A x B x C	Stock No.	Color	Unit
2 x 3 x .125	5023-LA-18-00	White	Feet
2 x 3 x .125	5023-LA-18-05	Ivory	Feet
2 x 3 x .125	5023-LA-18-07	Beige	Feet
2 x 3 x .125	5023-LA-18-10	Bronze	Feet
2 x 3 x .125	5023-LA-18-98	Mill	Feet

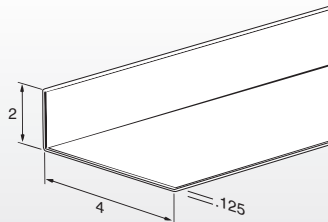

Features

Aluminum Angles | Length: 20'

A x B x C	Stock No.	Color	Unit
2 x 4 x .125	5024-LA-18-00	White	Feet
2 x 4 x .125	5024-LA-18-05	Ivory	Feet
2 x 4 x .125	5024-LA-18-07	Beige	Feet
2 x 4 x .125	5024-LA-18-10	Bronze	Feet
2 x 4 x .125	5024-LA-18-98	Mill	Feet

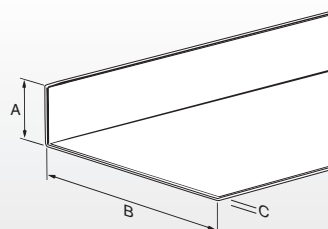

Features

Aluminum Angles | Length: 20'

A x B x C	Stock No.	Color	Unit
2 x 5 x .125	5025-LA-18-00	White	Feet
2 x 5 x .125	5025-LA-18-05	Ivory	Feet
2 x 5 x .125	5025-LA-18-07	Beige	Feet
2 x 5 x .125	5025-LA-18-10	Bronze	Feet
2 x 5 x .125	5025-LA-18-98	Mill	Feet

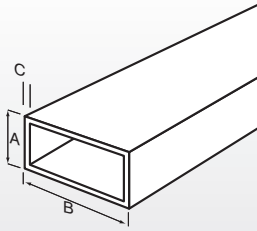

Features

Aluminum Rectangular Tubes | Length: 20'

A x B x C	Stock No.	Color	Unit
1 x 2 x .125	7012-AR-18-00	White	Feet
1 x 2 x .125	7012-AR-18-05	Ivory	Feet
1 x 2 x .125	7012-AR-18-07	Beige	Feet
1 x 2 x .125	7012-AR-18-10	Bronze	Feet
1 x 2 x .125	7012-AR-18-98	Mill	Feet

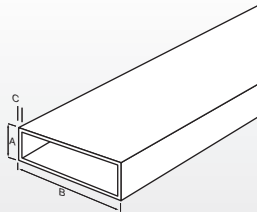

Features

Aluminum Rectangular Tubes | Length: 20'

A x B x C	Stock No.	Color	Unit
1 x 3 x .125	7013-AR-18-00	White	Feet
1 x 3 x .125	7013-AR-18-05	Ivory	Feet
1 x 3 x .125	7013-AR-18-07	Beige	Feet
1 x 3 x .125	7013-AR-18-10	Bronze	Feet
1 x 3 x .125	7013-AR-18-98	Mill	Feet

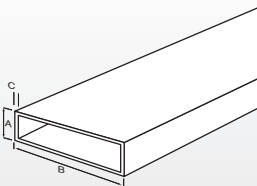

Features

Aluminum Rectangular Tubes | Length: 20'

A x B x C	Stock No.	Color	Unit
1 x 4 x .125	7014-AR-18-00	White	Feet
1 x 4 x .125	7014-AR-18-05	Ivory	Feet
1 x 4 x .125	7014-AR-18-07	Beige	Feet
1 x 4 x .125	7014-AR-18-10	Bronze	Feet
1 x 4 x .125	7014-AR-18-98	Mill	Feet

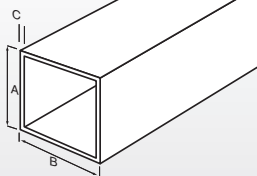

Features

Aluminum Tubes | Length: 20'

A x B x C	Stock No.	Color	Unit
2 x 2 x .125	7022-AR-18-00	White	Feet
2 x 2 x .125	7022-AR-18-05	Ivory	Feet
2 x 2 x .125	7022-AR-18-07	Beige	Feet
2 x 2 x .125	7022-AR-18-10	Bronze	Feet
2 x 2 x .125	7022-AR-18-98	Mill	Feet

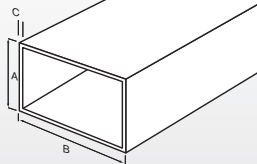

Features

Aluminum Rectangular Tubes | Length: 20'

A x B x C	Stock No.	Color	Unit
2 x 3 x .125	7023-AR-18-00	White	Feet
2 x 3 x .125	7023-AR-18-05	Ivory	Feet
2 x 3 x .125	7023-AR-18-07	Beige	Feet
2 x 3 x .125	7023-AR-18-10	Bronze	Feet
2 x 3 x .125	7023-AR-18-98	Mill	Feet

Extruded Aluminum Square Tubes

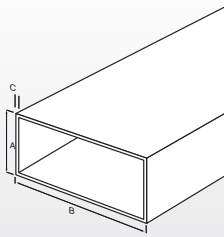

Features

Aluminum Rectangular Tubes | Length: 20'

A x B x C	Stock No.	Color	Unit
2 x 4 x .125	7024-AR-18-00	White	Feet
2 x 4 x .125	7024-AR-18-05	Ivory	Feet
2 x 4 x .125	7024-AR-18-07	Beige	Feet
2 x 4 x .125	7024-AR-18-10	Bronze	Feet
2 x 4 x .125	7024-AR-18-98	Mill	Feet

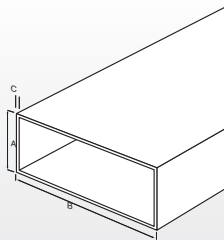

Features

Aluminum Rectangular Tubes | Length: 20'

A x B x C	Stock No.	Color	Unit
2 x 5 x .125	7025-AR-18-00	White	Feet
2 x 5 x .125	7025-AR-18-05	Ivory	Feet
2 x 5 x .125	7025-AR-18-07	Beige	Feet
2 x 5 x .125	7025-AR-18-10	Bronze	Feet
2 x 5 x .125	7025-AR-18-98	Mill	Feet

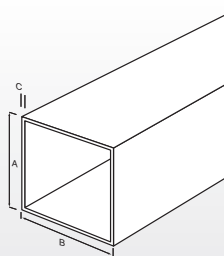

Features

Aluminum Tubes | Length: 20'

A x B x C	Stock No.	Color	Unit
3 x 3 x .125	7033-AR-18-00	White	Feet
3 x 3 x .125	7033-AR-18-00	Ivory	Feet
3 x 3 x .125	7033-AR-18-00	Beige	Feet
3 x 3 x .125	7033-AR-18-00	Bronze	Feet
3 x 3 x .125	7033-AR-18-00	Mill	Feet

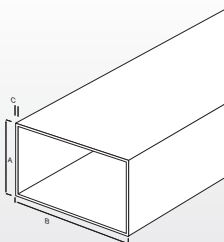

Features

Aluminum Rectangular Tubes | Length: 20'

A x B x C	Stock No.	Color	Unit
3 x 4 x .125	7034-AR-18-00	White	Feet
3 x 4 x .125	7034-AR-18-05	Ivory	Feet
3 x 4 x .125	7034-AR-18-07	Beige	Feet
3 x 4 x .125	7034-AR-18-10	Bronze	Feet
3 x 4 x .125	7034-AR-18-98	Mill	Feet

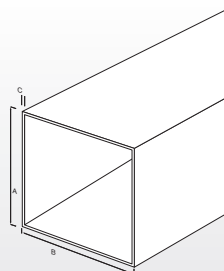

Features

Aluminum Tubes | Length: 20'

A x B x C	Stock No.	Color	Unit
4 x 4 x .125	7044-AR-18-00	White	Feet
4 x 4 x .125	7044-AR-18-98	Mill	Feet
4 x 6 x .250	7046-AR-14-98	Mill	Feet



For more information or architectural specifications please call 800-474-9404

© Rollingshield, Inc. 2006. All rights reserved. • www.rollingshield.com